

NOTICE OF PROPRIETARY RIGHTS THIS DOCUMENT CONTAINS CONFIDENTIAL DATA, INCLUDING TRADE SECRETS, PROPRIETARY TO TIMES MICROWAVE SYSTEMS. DISCLOSURE OF THIS DATA IS EXPRESSLY CONDITIONED UPON YOUR ASSENT THAT ITS USE IS LIMITED TO USE WITHIN YOUR COMPANY ONLY. ANY OTHER USE IS STRICTLY PROHIBITED WITHOUT THE PRIOR WRITTEN CONSENT OF TIMES MICROWAVE SYSTEMS.

SYM	REVISION DESCRIPTION	DFTM	DATE	APPD	APPD
A	RELEASED FOR PRODUCTION	Joslen	2016.03.29	TZ	2016.03.29

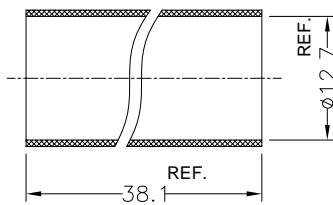

Heat Shrink Tube

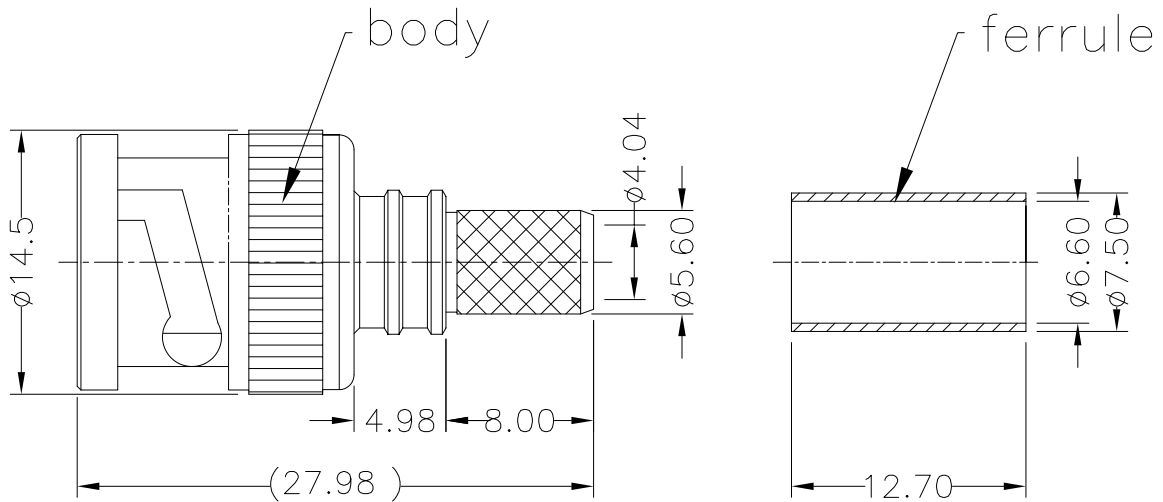
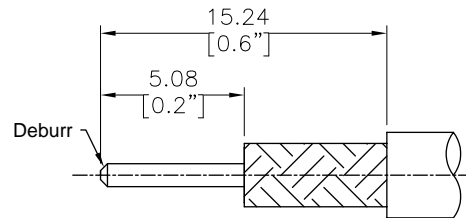

RECOMMENDED CABLE STRIPPING DIM'S
Connector adds: 15.7 mm

I. MATERIALS & FINISHES

Components	Materials	Finishes	Thk. (μ")
Body	Brass	Albaloy	80
Center Cont.	QBe2	Gold	50
Shell	Brass	Albaloy	80
Ferrule	Brass	Albaloy	80
Insulator	PTFE	--	--
Gasket	Silicone	--	--

II. ELECTRICAL PROPERTIES

Impedance (Ω):	75
Frequency Range (GHz):	DC to 2.5 GHz
Working Voltage (V):	1000
Insulation Resistance (MΩ):	≥10000
VSWR:	≤1.25
Insertion Loss(dB, f/GHz):	-0.1

III. ENVIRONMENT PROPERTIES

Temperature Range:	-55°C~+125°C
Thermal Shock:	MIL-STD 202G, Meth.107, Cond.B
Vibration:	MIL-STD 202G, Meth.204, Cond.B
Shock:	MIL-STD 202G, Meth.213, Cond I
Climatic Class:	IEC 60068 55/155/56
(2002/95/EC)RoHS:	Compliant





IV. MECHANICAL PROPERTIES

Center Cont.:	Captive
Outer Cont.:	Crimp
Coupling Nut Torque (N.m):	N/A
Cbl-Connector Retention Force (N):	200
Durability (cycles):	500

V. TOOLING

Stripping Tool: 3192-152/CST-240A
Crimping Tool: 3192-181/3190-608

According to Standard: IEC 61169-8

MATL:	UNLESS OTHERWISE SPECIFIED		DFTM.	Joslen							
	ALL DIMENSIONS ARE IN mm MACHINED SURFACES FINISH 1.6 RMS MAX. REMOVE ALL BURRS 0.15X45° MAX. BREAK MACHINE CORNERS 0.15X45° D MAX. FILLET R. TOLERANCES ON DECIMALS .X ±0.3 .XX ±0.15 ANGLES ±2° FRACTIONS ± N/A		DATE	2016.03.29							
USED ON: O			CHKD	KG		EZ-240-BM-75-X BNC Male (Plug) Straight Non-Solder Pin Connector for LMR-240-75 Cable					
			DATE	2016.03.29							
			APPD	TZ							
SCALE:	DWG SIZE	DO NOT SCALE DRAWING	CODE IDENT	68999	DATE	2016.03.29		1 OF 1	3190-6261		A